

The use of geodetic techniques in stability monitoring of floating structures

Vangelis Zacharis¹, Sotiria Dimitrellou², Konstantinos Politis², George Livanos², Vassilios Pagounis³,
Orthodoxia Arabatzi¹, Maria Tsakiri¹

¹ School of Rural and Surveying Eng., National Technical University of Athens, Greece
(arabatzi@survey.ntua.gr)

² Department of Naval Architecture, Univ. of Western Attica, Athens, Greece

³ Department of Surveying and Geoinformatics Eng., Univ. of Western Attica, Athens, Greece

Key words: *laser scanner, robotic total station, moving platform, inclining experiment*

ABSTRACT

The stability of a ship is one of the most important concepts about the vessel's performance, seaworthiness and safety. Any vessel must fulfil the intact stability criteria set by international maritime codes and regulations. This paper describes the use of geodetic measurements in monitoring the inclination of a model vessel during an inclining experiment. Initially, the geometric documentation of the vessel using terrestrial laser scanning measurements provided an accurate 3D digital model of the vessel. During the inclining experiment, a number of different loads were used in the vessel in order to estimate the heel angle. Special targets were placed on critical points of the vessel and continuous measurements were obtained from high precision robotic total stations at different conditions of loading the vessel. The measurements provided from the pendulum method were compared with the results obtained from the geodetic method in terms of accuracy and time.

I. INTRODUCTION

The study of ship dynamics is to date very advanced, however, intact ship stability remains still an unsolved problem. Based on the annual report of the European Maritime Safety Agency (EMSA, 2015) for the period 2011-2015, out of 178 very serious casualties with a ship, 5% were due to capsizing. To prevent such events, the International Maritime Organization (IMO) and other agencies have established intact stability criteria, which are mainly based on comparisons between casualty statistics and hydrostatics or dynamic models for a ship in beam seas. However, these criteria are not adequate as tools for assessing the real stability of a particular ship, because, they were developed over 40 years ago with statistics from out-of-date ships and without enough physical observations.

As demands for safety have significantly increased, there is a need for routine testing of the stability of each ship. Each research organization is attempting to assess stability by trial and error. Therefore, it is essential to establish a rational and efficient methodology for assessment of experimental stability and also to assess the intact stability of a ship with physical or theoretical modelling relevant to actual capsizing phenomena.

One of the most significant parameter for assessing the stability is the inclination of a ship in transverse direction. This is of particular importance in shipbuilding as it is directly related to the ship's safety and the possibility of its sinking or overturning in unfavorable conditions. The safety of ships, in relation to their intact stability, is controlled by criteria that have been set by international regulations. The basic elements involved in all calculations are the weight of the light ship and the distance GM of its center of gravity from the keel. The value of GM needs to be obtained at various stages from design to construction of a ship as this parameter at different stages differs from stage to stage.

Because it is almost impossible to have an accurate description of all the individual weights of the light ship (metal construction, mechanical and electrical equipment, etc.), the identification of the above elements is made experimentally by performing the inclining experiment. This experiment is performed by moving weights transversely to produce a known overturning moment compared with the known hydrostatic properties of the vessel. The measurements of the heel angle are taken using a long pendulum at a precision of several minutes of a degree.

In order to estimate these critical values with high precision, a need for geodetic methods is seen in this type of experiment. To the authors' knowledge, there is no relevant publication in the literature that implements geodetic techniques for accurate determination of stability parameters during the inclining experiment.

On the basis of these considerations, this paper describes the use of geodetic methods to derive values of stability along with the inclining experiment. Section 2 provides an overview of the basic stability parameters and Section 3 describes the inclining experiment performed in a model vessel. Section 4 describes the geodetic methodology implemented during the inclining experiment and gives details for the design and implementation of the proposed approach along with results. Section 5 summarizes by giving concluding remarks of this work.

II. SHIP STABILITY AND THE INCLINING EXPERIMENT

A. Ship stability

It can be defined in simple terms as its characteristics or tendency to return to its original state or upright state, when an external force is applied on or removed from the ship. A ship is at equilibrium when the weight of the ship acting down through the centre of gravity is equal to the up thrust force of water acting through the centre of buoyancy and when both of these forces are in same vertical line. A ship will come to its upright position or will become stable, when an external force is applied and removed, if the centre of gravity remains in the same position well below the metacentric height of the ship. When the ship is inclined, the centre of buoyancy shifts from B to B_1 , which creates a movement and the righting lever returns the ship to its original position and makes it stable (Fig. 1). M is the metacenter and GZ is the righting lever.

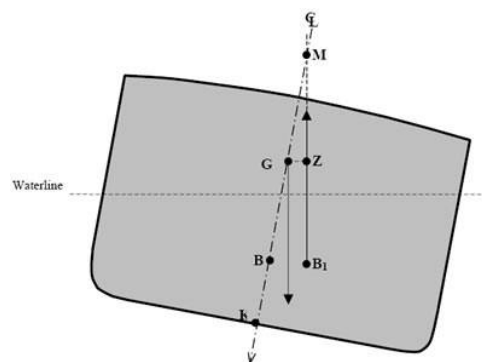

Figure 1. Schematic of a vessel's stability parameters

A ship is seaworthy if it fulfils two important stability criteria – Intact and Damage stability. They are both very important factors that govern the overall stability of the ship. The intact stability requirements along with the damage stability criterion varies from ship to ship. Under all the criteria as applicable, vessel margin line (an imaginary line drawn 75mm below the free board deck) should not be submerged after the damage.

When the ship tilts on any of its sides i.e. port or starboard and does not return back to its upright position, it is known as heeling of the vessel. Heeling is unsafe for ship, its machineries and people onboard.

The main reasons of ship's heeling are strong winds, hard and speedy turns and uneven cargo loading. Out of the three reasons, the most common cause is uneven cargo loading and unloading.

An important parameter for the safety of a ship is the metacentric height which has the role in setting the loading capacity and stability of the ship. The initial metacentric height of the ship is determined by an inclining experiment after the ship is completely built. When a ship is heeled by an angle, the centre of buoyancy is shifted from B to B1 (cf. Fig. 1). The metacentric height (GM) is the distance between the centre of gravity and metacentre of the ship and it is used to calculate the stability of the ship.

The International Maritime Organisation (IMO) regulations specify that an inclining test shall be performed for any single ship, regardless of her size, and for every single cargo ship, regardless of its length. The theoretical background of the inclining test is explained in Chakrabarti (2005). Exemption from the test is possible if the ship is one of a series of ships and basic stability data are available from the inclining test of a sister ship in the same series.

III. INCLINING EXPERIMENT ON A VESSEL MODEL

In this work, a model vessel was used in a water tank which are both located at the Department of Naval Architecture, of the University of Western Attica. The model has a length overall of 3.19m, breadth 41.50cm, moulded depth 24.50cm, weight 31.5 kg and is floating in a water tank of length 11m, width 1.35m and height 0.80m. Prior to the inclining experiment which was also monitored by geodetic methods, the vessel was geometrically documented because of the lack of designs. A description of the geometric documentation method and the inclining experiment is given in the following.

A. Accurate model of the vessel

For the creation of a 3D digital model of the vessel, terrestrial laser scanning was used. Then the 3D model was used in the Rhinoceros software to allow specific naval calculations being performed. The data acquisition was carried out with a Leica Scanstation 2 terrestrial laser scanner (www.leica.com) and four scans in total were required to capture the boat (Fig.2). The data sampling was defined at 6mm. the registration of all scans into a common coordinate system was achieved with an accuracy of less than 1cm.

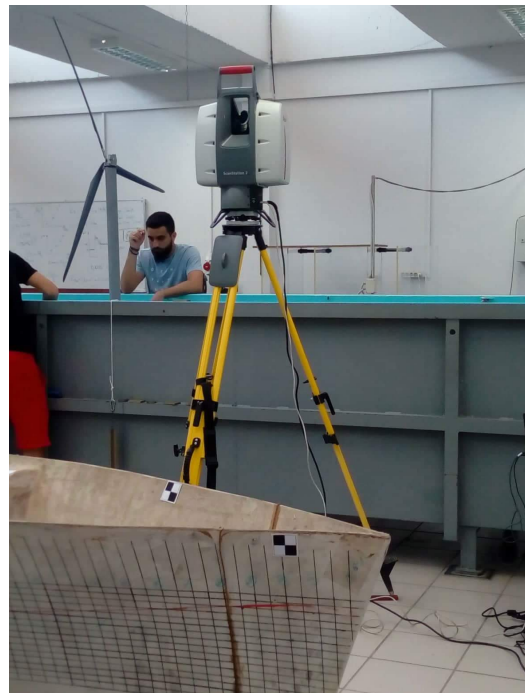
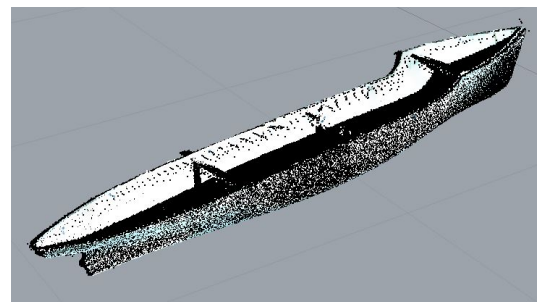
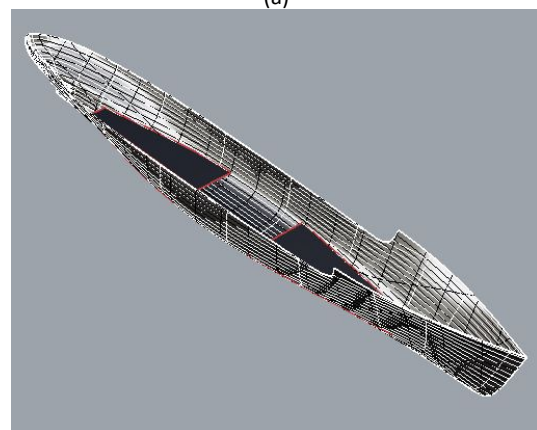

Figure 2. Geometric documentation of boat



(a)



(b)

Figure 3. (a) Registered point cloud of boat Geometric documentation of boat (b) Polygonal model

B. Inclining experiment

The requirements and the methodology of the inclining test are specified by IMO and other international associations. The main idea of the experiment is to determine the metacentric height (GM), which dominates stability in the light

displacement condition and be compared with the design value.

The inclining test is usually performed inshore in calm weather, in still water, and free of mooring restraints to achieve accuracy. The GM position is determined by moving weights transversely to produce a known overturning moment in the range of 1-4 degrees if possible. Knowing the restoring properties (buoyancy) of the vessel from its dimensions and floating position and measuring the equilibrium angle of the weighted vessel, the GM can be calculated. The measurements are taken using a pendulum which an example of a typical arrangement is shown in Fig. 4.

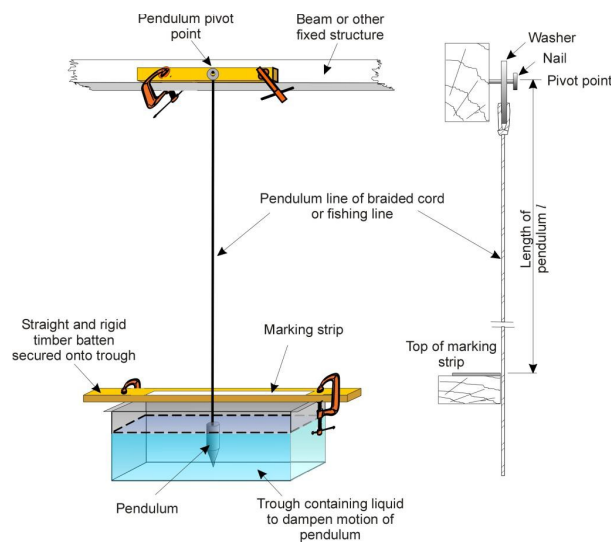

Figure 4. Example of a pendulum typical arrangement

The standard inclining test employs eight distinct weight movements where movement by the eighth weight shall be a recheck of the zero point. During the experiment, seven weights of 2.2 kg each were placed on its deck, in symmetrical positions, and in such a way as to cause zero heel angle in calm water (Fig. 5). The mean draft is measured to $T=8.95\text{cm}$ and the displacement Δ is calculated by means of the hydrostatic diagram of the vessel.

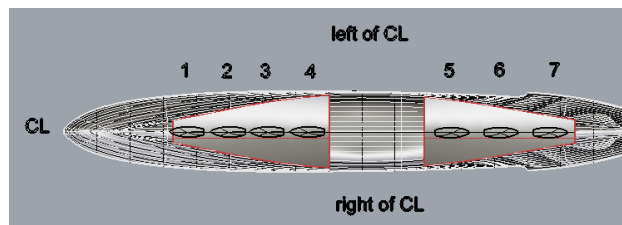

Figure 5. The vessel model with the weights and zero heel angle in Rhinoceros

Then, the weights were moved in the transverse direction sequentially at known distances d , resulting to heel angles ϕ (Fig. 6). The transverse inclination of the vessel is measured with a pendulum of 0.05° precision. According to the measurements the length of the righting lever $GZ = w * d * \cos\phi / \Delta$ is calculated for each loading condition. The righting lever curve as a

function of the heel angle is finally determined showing a successful experiment.

- In the first phase of the experiment the weight No4 was moved from the CL to the right by 15 cm. The heel angle was measured to 4.6° .
- In the second phase an extra weight was moved from CL to the right. The weight No4 remained in place and the weight No3 was moved by 10 cm. The heel angle was measured to 7.9° .
- In the third phase, the weight No4 was moved from CL to left by 8.5 cm. The heel angle was measured to 2.9° .
- In the fourth phase (Figure 3), the weight No4 remained in place (left by CL) and the weight No3 was moved from CL to the right by 10 cm. The heel angle was measured to 0.05° .



Figure 6. The vessel model in the water tank during the inclining experiment

IV. GEODETIC MEASUREMENTS ON THE VESSEL MODEL

According to IMO regulations, all tests used to establish the stability characteristics of a vessel must be undertaken in a manner that achieves the required accuracy and permits subsequent independent review and verification by third parties. Whilst the pendulum is of adequate accuracy for this type of test, it clearly lacks of the high precision of other types of measurements. In the literature, there is no published work on using geodetic techniques to measure the inclining experiment. Therefore, prior to performing measurements with geodetic instruments, the design phase was essential to establish the most suitable way to collect measurements synchronized in real-time.

A. Design

For this work, three high precision robotic total station instruments were available, namely a Leica TS30 (quoted precision $\pm 0.6\text{mm} \pm 1\text{ppm}$), a Trimble S3 and a Trimble S6 (quoted precision $\pm 2\text{mm} \pm 2\text{ppm}$). The main problem identified using three different types of total stations was their timing synchronization. This is because each instrument has its own timer, at its own time scale. Therefore, the measurements from each instrument are in different time scales and should somehow become compatible.

A number of in-house actions were performed in order to find the most efficient way of instrument synchronization. For example, suitable scripting was developed to read the serial port of an instrument in real time and tag each record of the measurements with the timestamp of the computer clock. The idea was to run three copies of the script at the same time (on the same computer), each one monitoring a different serial port (USB to Serial) so three different files with a single time scale (computer time) would be produced. Alternatively, a variant was tested, which manages the serial ports (and thus the instruments) from a single script (using threading techniques, i.e. each instrument is controlled by a separate CPU process to allow recording at rates higher than 1Hz) with "relative" success. However, due to practical constraints, this idea could not be implemented.

Due to the fact that the available instruments (Trimble S3 and S6) do not allow streaming of their measurements, a more practical approach was finally implemented. The main idea is that if all three total stations (TS30, S6 and S3) simultaneously aim at the same prism (e.g. a Leica 360°) and can monitor it, then every change in the prisms position will be seen as a change in the acquired measurements of each instrument along with the associated network errors (i.e. instrument positions), instrument errors (i.e. centering, leveling) and sighting errors (i.e. point of sight, prism constant). Using the "common" positions of the points of sight and the corresponding times in the time scale of each instrument, it would be possible to calculate a time shift between the Trimbles' timer and the Leica's timer. Since the Leica TS30 can measure at rates higher than 1Hz, synchronization would be possible at 1s.

B. Measurements

Prior to acquiring measurements for the inclining experiment, a set of measurements to calibrate the timers of the three instruments were made aiming at the same prism. At a second stage, the inclining experiment took place as discussed in IIIB section. Fig. 7 shows the position time series taken during the test for one prism (in red from TS30, green from S6 and blue from S3).

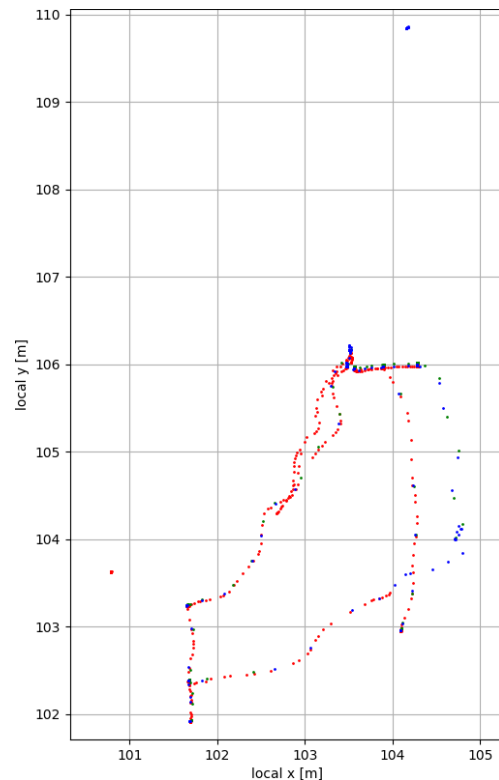

Figure 7. The position plot of the Leica 360 prism during the time synchronization measurements.

C. Analysis

Moving on to the analysis, the issue of synchronization was essential due to the fact that it was not dealt with at the instrument level. Therefore, it was decided to identify "common" positions in the position time series of the three instruments. From four pairs of common positions, the shift Δt values were determined so that the S3 and S6 Trimble timers would synchronize with that of the TS30 Leica instrument.

The next step was to synchronize the measurements from the three different instruments at the common epoch of 1s. Redundant observations of the TS30 instrument were deleted and only at 1s interval were maintained. Fig. 8 depicts the positions of all instruments (i.e. the TS30 is at 5Hz in red, S6 in green and S3 in blue).

Using the synchronized positions for each prism it is easy to define the plane of the prisms by the external product of any two vectors of the plane (e.g. TS30-S6 and TS30-S3). This vector is normal to the plane and describes it completely. When dividing it with its norm, then the resulting normalized vector allows the direct determination of its orientation with respect to the local system, and hence the level gradients in each of its three components.

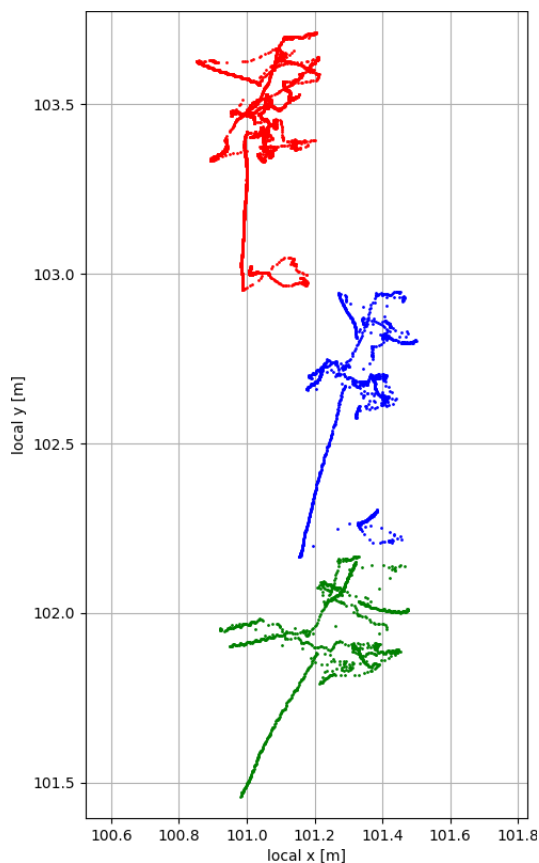

Figure 8. The position plot of the three prisms from the three total stations during the inclining experiment.

Heel angle is the rotation of the vessel with respect to its longitudinal axis. It corresponds to “Roll”, when using the Roll – Pitch – Yaw notation. The given instrument precision and the model’s dimensions set the resulting resolution of the heel angle to 0.02° .

Heel angle values were filtered using a 5th order Butterworth Low Pass filter (Bianchi & Sorrentino, 2007), so as to minimize the fluctuations caused by external interference such as waves in the tank, or the effect of the weights operation.

Fig. 9 shows the measured Heel angle plotted against time (raw values above filtered values). Negative values show rotations towards right. The individual values are shown in blue. The mean values are shown in red, along with their standard deviation. Table 1 shows the experiment results against the ones produced using the clinometer.

Table 1. Comparison of heel angle between the inclining experiment and the total station method

Phases of experiment	Raw Heel angle [degrees]	Filtered Heel angle [degrees]	Clinometer value [degrees]
	+0.15 ± 0.093	+0.15 ± 0.018	+0.1
Phase 1	-4.85 ± 0.257	-4.94 ± 0.187	-4.6
Phase 2	-7.83 ± 0.180	-7.73 ± 0.062	-7.9
	-0.67 ± 0.416	-0.28 ± 0.051	-0.4
Phase 3	+2.53 ± 0.292	+2.46 ± 0.142	+2.9
Phase 4	+0.42 ± 0.198	+0.45 ± 0.115	+0.05

From Table 1, it is seen that by filtering raw data the accuracy is increased by roughly an order of magnitude. It is also seen that the values from both methods are quite close with a mean of -0.067 degrees and rms of 0.28 degrees for the raw values. Filtered data agree in -0.007 ± 0.32 degrees. The inclining method provides values given by inclinometers which does not have the resolution of the total station measurements. In this experiment, the pendulum used has resolution of 0.05 degrees. Also, it does not provide measurement redundancy and thus, it is not possible to estimate the quality of the solutions. The closeness of the values in the two methods indicates that the total station method can provide calibration of the inclining method while estimating with higher accuracy the heel angle attended with quality indicators.

V. CONCLUDING REMARKS

In this paper, an experimental methodology to determine parameters of the stability of the boat in the light displacement condition and compared with the design values is presented. The monitoring network comprised three robotic total stations and a set of three prisms installed on the model vessel.

When compared the results of the heel angle from the two methods, these were close. However, the higher accuracy along with the higher frequency of the total station measurements allow for efficient study of displacement data for a great range of scenarios related to ship’s stability.

The monitoring approach and procedure developed has been mainly applied in a context relevant to comparisons with the inclining experiment.

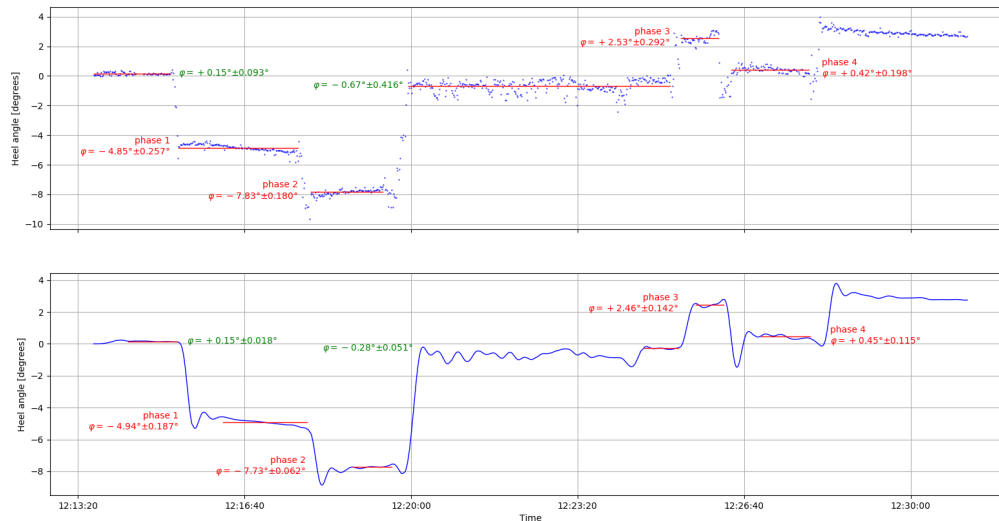

Figure 9. Heel angle measurements; top: raw values, bottom: filtered values.

Nevertheless, this methodology can be well adapted and efficiently used also in cases of accelerations that could affect the stability of the vessel structure (e.g. due to accident scenarios). The observed displacement time series can aid in the monitoring of the progressive deformation of various parts of the boat such as the hull.

The issue of time synchronization is essential in this methodology. Clearly, it is best to deal with this at the instrument level. In this work, an approach based on the measurement level was designed which produced satisfactory results.

References

- Bianchi G., Sorrentino R. (2007). *Electronic filter simulation & design*. ISBN 978-0-07-149467-0. pp. 17–20. McGraw-Hill Professional.
- Chakrabarti, S. K. (2005). *Handbook of Offshore Engineering*. ISBN: 978-0-08-044381-2, Elsevier Science.
- European Maritime Safety Agency EMSA (2015). Annual overview of marine casualties and incidents, www.emsa.europa.eu/publications/